

**APS300XS/Si** / Series

---

**REGULATED DC  
POWER SUPPLY**

---

**APS3003S/Si APS3005S/Si**

---

**Users Manual**

---

Thanks for using our products, please read this manual thoroughly before operation.

## SAFETY GUIDELINES

- Don't clog, placed on equipment.
- To avoid collision or rough, damage to equipment operation.
- Don't use equipment, electrostatic discharge.
- Don't hinder cooling fan.
- In equipment, connected to the power supply, don't make equipment work charged.
- In the service personnel, didn't get confirmation shall remove equipment before secretly.

## EQUIPMENT SUPPLY WARNING

- Input voltage: AC110V  $\pm$  5%, Frequency: 60Hz
- With reliable grounding cord, should be to avoid shock.

## THE FUSE WARNING

- **APS3003S/Si**: fuse types 3.15A/250V, **APS3005S/Si**: fuse types 4A/250V.
- Before starting in power, confirm the fuse has installed.
- To prevent fire, and ensure the fuse to replace designated specifications.
- Before replacing the fuse, be disconnected from the power of the connection.
- Before replacing the fuse, be confirmed the fuse.

## EQUIPMENT CLEANING

- Before cleanness, equipment should be connect the power cable.
- Clean equipment with cleaning wet soft cloth and do not clean equipment with mild detergent spray liquid cannot be used.
- Don't use chemical solvents, and stimulating cleaner as benzene, toluene, xylene, acetone, etc.

## WORKING ENVIRONMENT

- For indoor workplaces, and no direct sunlight and large dirt poor and insulation.
- Relative humidity less than 80%.
- Altitude less than 2000m.
- Operating temperature range 0°C -40°C

## STORAGE ENVIRONMENT

- Storage Venue: indoor
- Relative humidity less than 70%
- Storage temperature range -10°C -70°C



## SUMMARIZATION

**APS3000S/APS3000Si** series belongs to single output high-precision DC regulated power supply, both output voltage and current rated range are continuous adjustable, the constant voltage/the current constant (CV/CC) are automatic conversion working mode with independent display output voltage and current output, various protection function includes limiting current and voltage step-down and short circuit protection and overheating protection, a series of design products are applied in factories and commissioning and maintenance and laboratory and etc.

### SERIES OF PRODUCTS

Model	Rated Rang	Voltmeter	Ammeter
APS3003S	0~30V/0~3A	3 digit	3 digit
APS3005S	0~30V/0~5A	3 digit	3 digit
APS3003Si	0~30V/0~3A	3 digit	4 digit
APS3005Si	0~30V/0~5A	3 digit	4 digit

## THE MAIN FUNCTION

### Features

- Cooling fan control switch control (*by removing*).
- Compact structure and light weight.

### Performance

- Constant-voltage/constant-current way to work.
- Adjustable voltages and currents with coarse and fine tuning knob.

### Protection function

- Overload protection function.
- Overheating protection function.
- Short-circuit protection function.

## PRINCIPLES OUTLINED

**This machine consists of the following several parts.**

- The AC power input.
- transformer.
- Van bias source includes rectifier, filtering, preset adjustment and benchmark voltage source.
- The main adjustment circuit, including the main rectifier and filter, serial adjustment, current and voltage comparator comparison, voltage amplifier, remote devices and power relay control circuit.

**The display circuit structure of block as below. Single-phase power through the input power connection to the transformer.**

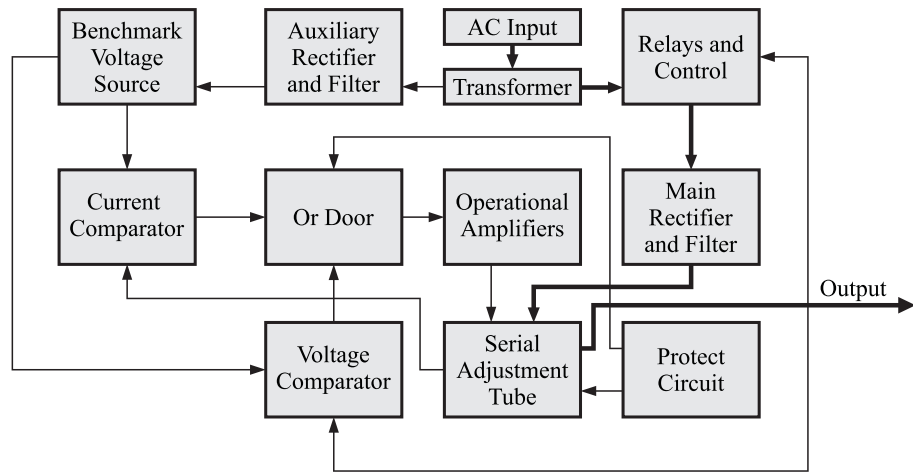

### Auxiliary rectifier

Aided rectifying by CR2 and filtering by capacitance C2 and C12 bias voltage and bias voltage provide to pre-amplifier adjustment IC4 tube and Q2 and also provide a stable voltage to other modules.

### Main rectifier

For the main rectifier bridge rectifier, the wavelet filter capacitance (C13 C14) followed for output power supply, then through a series of adjustment, finally to adjust pipe output terminals.

### Fault current limiter

The IC3 have limited Current when the current exceeds default, the IC3 began to work and reduce the current output.

Q2 provide benchmark voltage and the IC1 is used to compare the benchmark voltage and feedback voltage of amplifier and to adjust output voltage after compare calibration results compare T1.

### Overload

The IC3 began to control current value RL1 and to limit output current value when the equipment overload and the relay circuit control power of series adjustment tub.

## THE FRONT PANEL

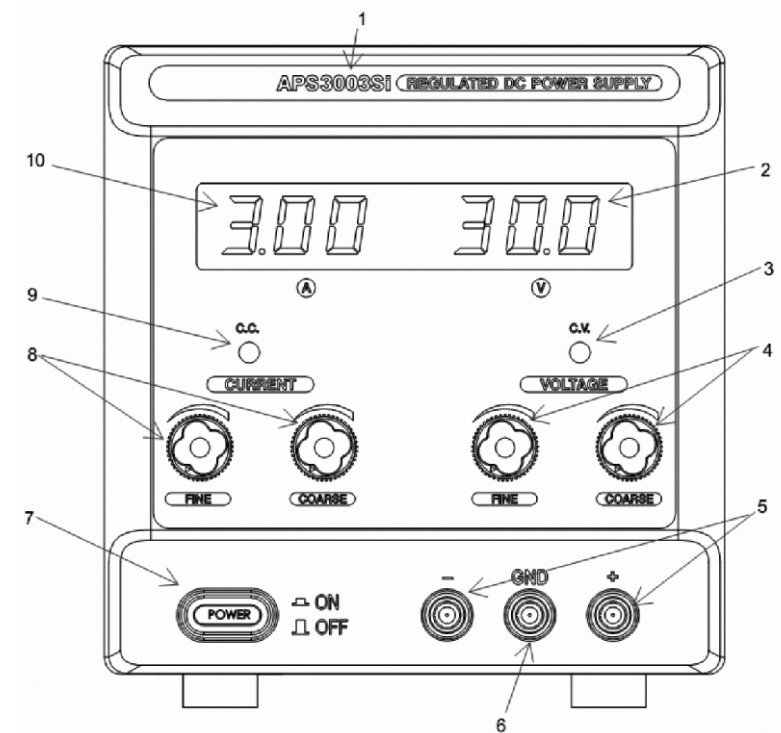

- ① Specifications tags
- ② Output voltmeter
- ③ Constant voltage mode indicator,
- ④ The adjustable knob of limited voltage (*coarse and fine tuning*)
- ⑤ Output terminals
- ⑥ Grounding terminals
- ⑦ The power switch
- ⑧ The adjustable knob of limited current (*coarse and fine tuning*)
- ⑨ Constant current mode indicator
- ⑩ Output ammeter

## REAR PANEL

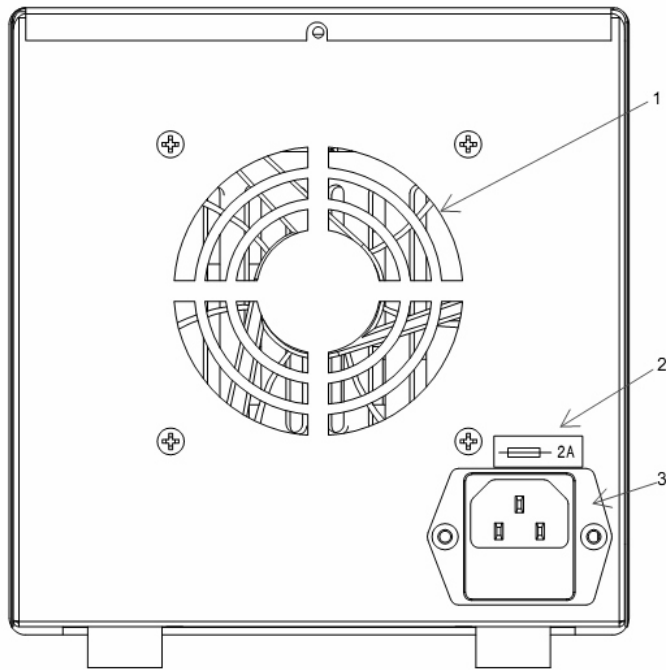

- ① The cooling fan
- ② Fuse specification stickers
- ③ Integrated fuse power socket

## EQUIPMENT OPERATION

Before starting the power supply, please confirm voltage whether accord with equipment input voltage specification.

### 1. Connect the power cable

Before starting the power supply, please confirm input AC voltage whether accord with equipment input voltage specification, the power cable one plug insertion device the outlet ③, the other connects power supplies. (the first step is to close the power switch ⑦).

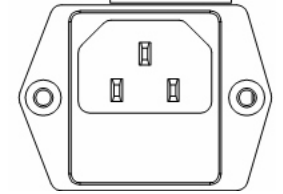

### 2. Power on



Press the power switch ⑦ of front panel, the voltmeter ② and ammeter ⑩ display both output voltage value and output current value, the green light 3 of Constant voltage working mode (CV) will bright.

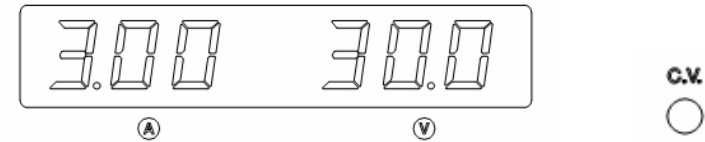

**Note:** Output state for illustration shows 30V/3A, if there is no access to load, ammeter ⑩ display 0.00A.

### 3. power off



Press the power switch ⑦ is closed equipment.

## 4. Load connection

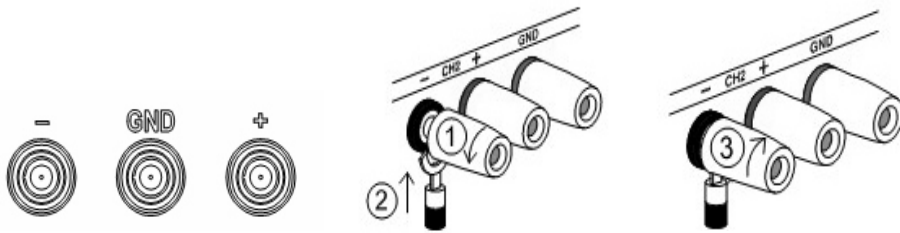

Load and output terminals connecting cable connection, please attention output terminals for polarity, the red output terminal is positive +, the black output terminal is negative -, the green output terminal is ground, Proceed as follows:

- (1) counterclockwise loosen output terminals.
- (2) Insert terminals.
- (3) Clockwise tighten output terminals.

The below table for load cable diameter and current averageserving 450A/cm<sup>2</sup>.

Wire Size (AWG)	Maximum Current (A)
20	2.5
18	4
16	6
14	10
12	16

## OUTPUT ADJUSTMENT

### 1. Voltage adjustment



After startup, adjusting voltage knob ④ on the required values, the output voltage range is 0~30V continuous adjustable, adjust knob (coarse ) with fine tuning knob (fine) and output voltage accuracy is 0.1V. output voltage meter display output voltage For 30.0V.

### 2. Limit current adjust



Remove load adjusting voltage adjustment knob, the output voltage will be transferred to low voltage (e.g. 1V) and short-circuit output terminals ⑤ positive + and negative -, adjust current knob (coarse) to value, the current adjusting range is 0~3A continuous adjustable with fine tuning knob (fine) may fine control to 0.01A precision (APS3003Si / 3005Si series for 0.001A), output ammeter display adjustment current value For 3.00A. After adjusting remove short route from output terminals.

**Note:** when adjust the current limit, please do not short-circuit for a long time, in order to avoid damage.

## CONSTANT VOLTAGE AND CONSTANT CURRENT CV/CC PRINCIPLE DESCRIBE

This device can be in constant voltage and constant current CV/CC work mode, the automatic conversion restricted load current state and setting current value of the comparison results.

### 1. constant voltage CV work mode

The current value of output less than the current setting ,power is working in constant voltage CV work mode, then the front panel of constant voltage (CV) green lights ③ will bright, output voltage controlled and will set values are the same, the current will vary with the load.

C.V.



### 2. Constant current CC work mode

When the current value of output more than the current setting , devices is working in constant current CC work mode, then the front panel of constant current (CC) red lights ⑨ will bright, output current controlled and will set

C.C.



values are the same, Due to the limited power output, the output voltage can not overload, value will be low. when the current value of output less than the current setting, equipment will be automatically converted into constant-current working state. (As shown in figure)

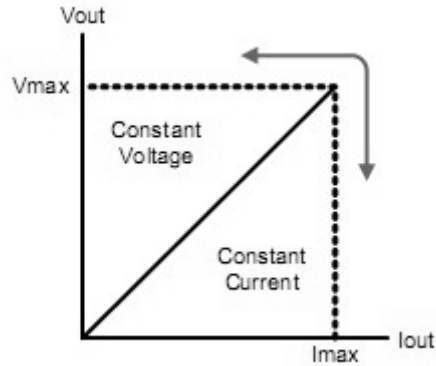

## THE FUSE REPLACE

**Step 1.** From the socket disconnect the power, using a small tool to remove the fuse.

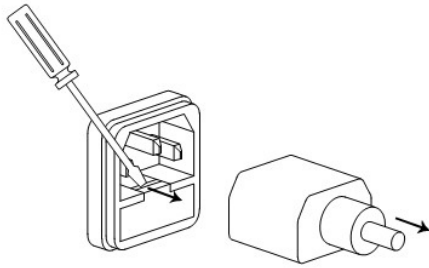

**Step 2.** Replacing the fuse

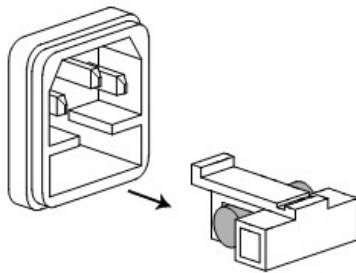

### The fuse ratings

AC 220V: APS3003S/Si T2A/250V  
 APS3005S/Si T3A/250V

## TECHNICAL INDICATORS

This index applies to work on less than 30 minutes and +20°C - +30°C environmental temperature.

### Rated output value

- Voltage 0~30V
- Current 0~3A (APS3003S/Si)  
0~5A (APS3005S/Si)

### Voltage regulation

- Power regulation less than 0.05%+3mV
- Load regulation less than 0.1%+3mV  
(Rated current less than 3A)
- Load regulation less than 0.1%+5mV  
(Rated current more than 3A)
- Ripple and noise less than 3mVrms  
(5Hz~1MHz)

### Current regulation

- Power regulation less than 0.2% + 3mA
- Load regulation less than 0.2% + 6mA
- Ripple and noise less than 3mArms
- The recovery time less than 300μs  
(Full load of 50%, minimum load is 0.5A)

### Ammeter

- APS3003/5S  
Three dights 0.56 inch LED display
- APS3003/5Si  
Four dights 0.56 inch LED display

### Voltmeter

- APS3003/5S  
Three dights 0.56 inch LED display
- APS3003/5Si  
Three dights 0.56 inch LED display
- **High voltage test:** Leakage current less than 1mA (Test conditions: Input voltage to ground 1700Vac/2 second)

- **Insulation resistance:** Insulation resistance more than 100MΩ  
(Test conditions: Input voltage to ground 500Vdc/5 second)

### Working environment: indoor

- Altitude less than 2000m
- **Environmental temperature range:**  
0°C~40°C
- Relative humidity less than 80%

### Storage temperature

- **Environmental temperature range:**  
10°C~70°C
- Relative humidity less than 70%

### Input voltage

AC110V ± 5%, Frequency: 60Hz

### Accessories

manual, power cable

### Size

150(W)x160(H)x260(D)mm

### Weight

3.3kg APS3003S/Si  
 3.9kg APS3005S/Si